

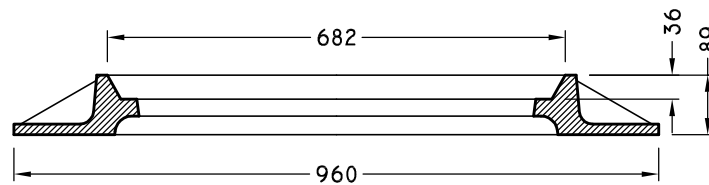

89mm SHALLOW FRAME

TF-67FS

PLAN

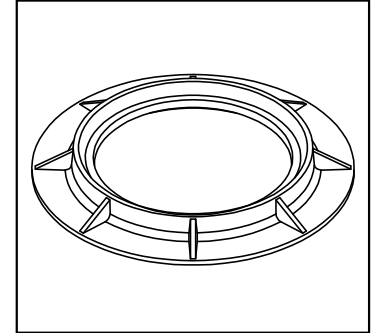
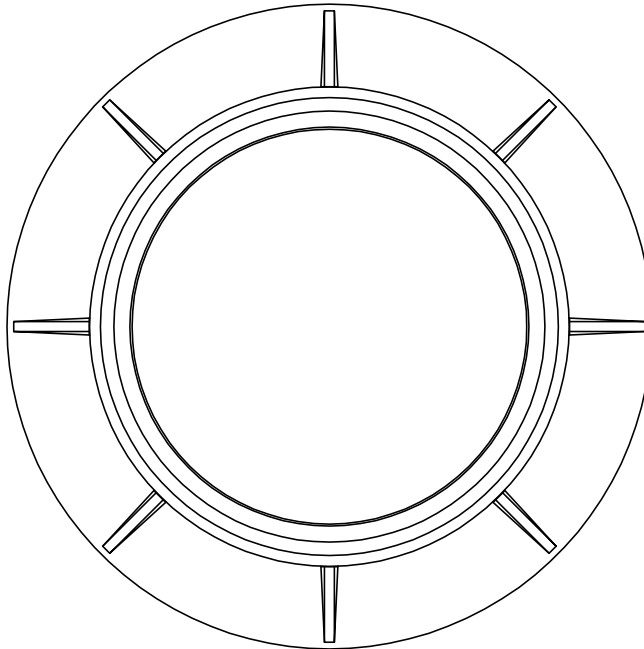

SECTION

ISO 9001-2000 CERTIFIED

RATED FOR HS-20 LIVE LOAD

MEASUREMENTS IN MILLIMETERS

TROJAN INDUSTRIES INC.
CALGARY • EDMONTON, ALBERTA